

# Paralela

Nahtrang Studio

# user manual

**Axolight**

o—o—o paralela  
nahtrang studio



Daniel Vila and Ester Pujol, industrial designers, founders of Nahtrang Studio, Barcelona (Spain).



*"Draws inspiration from the memory of the light reflections of an architectural element of our origins, a particular type of shutter typical of the Mediterranean tradition".*



ACTUXC30EXBI1ER + ACTESTACO01XXER + ACDISTSMXORXXER + CANOPY + DRIVER

# horizontal suspension

INTERVIEW WITH  
DANIEL VILA AND  
ESTER PUJOL

Can you tell us a bit about what the initial inspiration was for this collection?

We were thinking about the immaterial nature of light, the way a lamp can hold light, giving it a form of its own.

We were inspired by the idea of tightening the light.

We like the idea of a ladder of illuminated parallel lines, ordered by gravity, connected together in a point where each lamp rests and holds the next one, developing a visual dialogue, a symphony of light.

What is most important for you when designing lighting fixtures?

We keep in mind not only the lamp itself, but also what do we want to communicate, what kind of environment we want to generate. Illumination for us is, without any doubt, the most important element to create a pleasant atmosphere. It has the power to change moods, to modify our biorhythms... so we feel a huge responsibility designing it. Starting from there, we try to wrap all of this in the most suitable envelope.

What inspires your work?

An exhibition, a song, a book or a trip, light, tranquility and keeping the mind awake... all of this works for us, but inspiration goes further. There is no formula or technique that makes us work mathematically when we face a new project. We are lucky to have a good capacity of understanding that helps us unlock an idea through reflection or coherence. Over time, we have learned to be more efficient in order to achieve the goal in the best possible way.

○○○ paralela



ACTUCC30XXLA1ER + ACDISTSXMORXXER + ACTUXX30XXBI2ER + ACDISTBIFORXXER + ACTUCX30XXBI2ER  
+ ACDISTSXMORXXER + ACTUC30XXLA1ER + ACCAVOEL4X001NE + CANOPY + DRIVER

vertical  
suspension





ACTUXX30XXMI1ER + ACDISTMIXAPXXER +  
ACTUXX30XXMI1ER + DRIVER

# wall



ACTUXX30XXLA1ER + ACDISTSXPXXER + ACTUXX30XXLA1ER  
+ 2 X ACSTAFFA001XXER + DRIVER

floor



PTPARALELA30XNE  
ACCONTROLPT0001

table





# Paralela

Nahtrang Studio

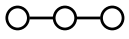

Collection composed of: modular and multidimensional suspensions, wall and ceiling lamps; floor and table lamps, made of glass.

## COLOURS



white

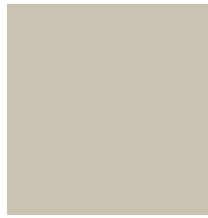

greige

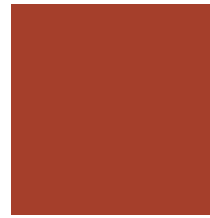

earth red



pine green  
limited edition



black

## System elements for single module configuration (DRIVER NOT INCLUDED)

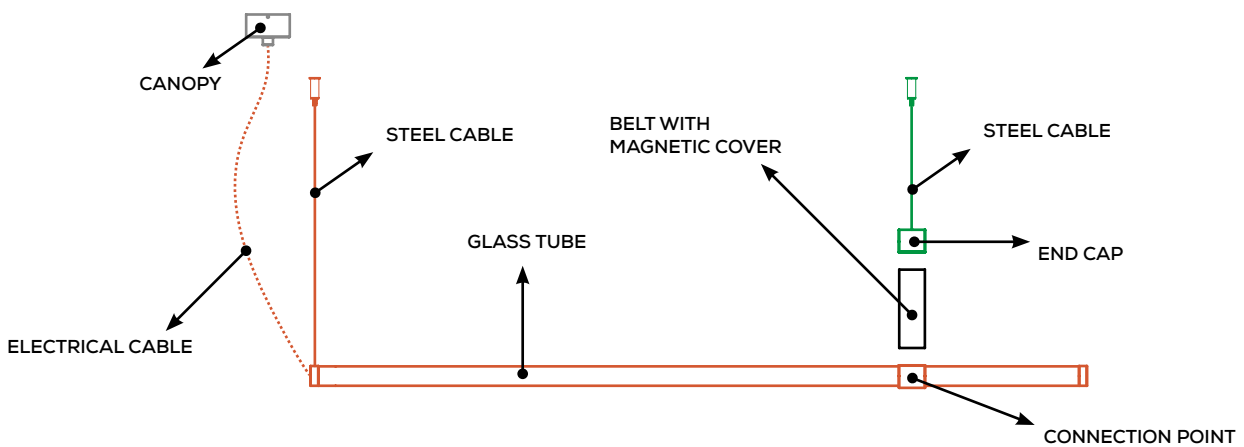

ACTUXC\_\_EXBI1\_\_    ACDISTSMXORXX\_\_    ACTESTAC001XX\_\_    ACCANOPYTO004\_\_

## System elements for multiple modules configuration (DRIVER NOT INCLUDED)

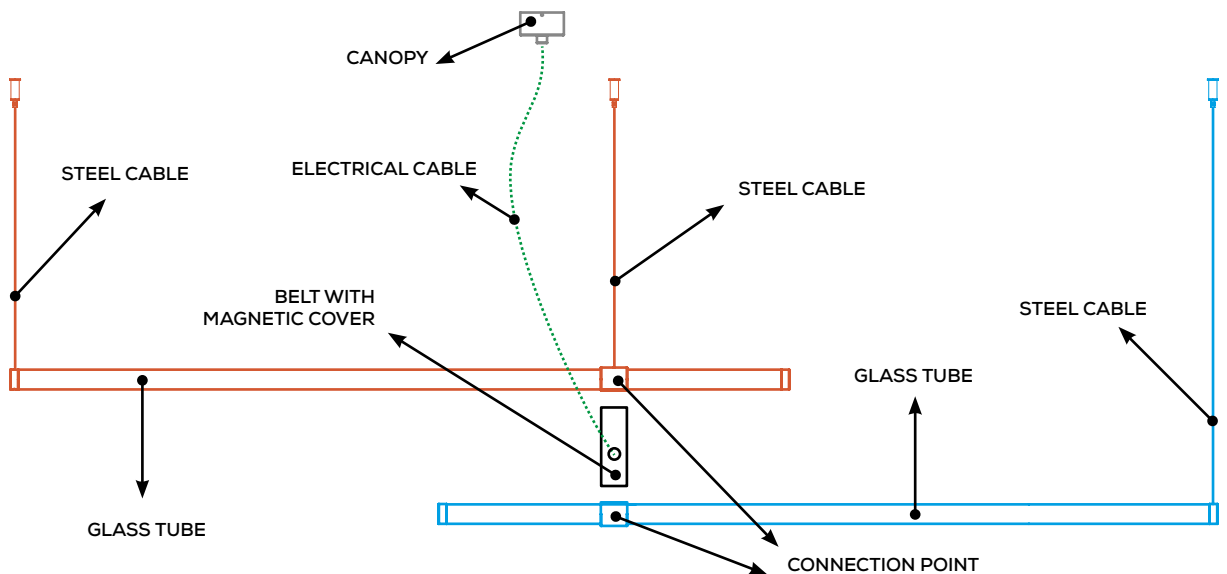

ACTUCC\_\_XXBI1\_\_    ACDISTSMFORXX\_\_    ACTUXC\_\_XXBI1\_\_    ACCANOPYTO004\_\_    ACCAVOEL2X001\_\_

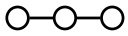

## Horizontal suspension 46 3/4" - 1 connection point

PARALELA HORIZONTAL SUSPENSION - GLASS TUBE 46 3/4" 1 CONNECTION POINT (DRIVER NOT INCLUDED)

Type	Article	Steel cable on connection point	Steel cable external cap	CCT	Electrical cable	Code	Size	Connection point	Colours	LED - Source
AC	TU	X without	C with	27 2700K	X without	X	BI 46 3/4"	1	BC white	~19W (~1418lm)
		C with		30 3000K	E with				ER earth red	
									GE greige	
									NE black	
									PG pine green limited edition	



DRY LOCATION CRI>90 24Vdc **LED**

example composition code AC TU C C (27)\* X X BI 1 (PG)\* ○ CCT and Colours have no impact on prices

lb 2.20 ft³ 0.25

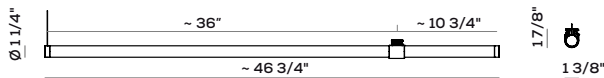

GLASS TUBE 46 3/4" + STEEL CABLE (118 1/8") + 1 CONNECTION POINT UP

example composition code AC TU X C (30)\* X X BI 1 (ER)\*

lb 2.65 ft³ 0.25

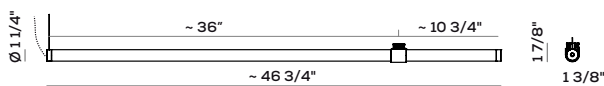

GLASS TUBE 46 3/4" + STEEL CABLE (118 1/8") + ELECTRICAL CABLE (157 1/2") + 1 CONNECTION POINT UP

example composition code AC TU X C (27)\* E X BI 1 (GE)\*

lb 2.20 ft³ 0.25

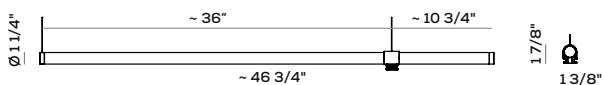

GLASS TUBE 46 3/4" + STEEL CABLE (118 1/8") ON CONNECTION POINT + STEEL CABLE (118 1/8") + 1 CONNECTION POINT

example composition code AC TU C C (30)\* X X BI 1 (PG)\*

lb 2.65 ft³ 0.25

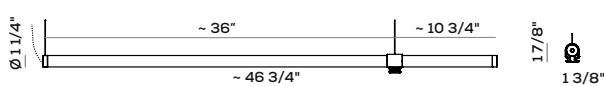

GLASS TUBE 46 3/4" + STEEL CABLE (118 1/8") ON CONNECTION POINT + STEEL CABLE (118 1/8") + ELECTRICAL CABLE (157 1/2") + 1 CONNECTION POINT

example composition code AC TU C C (27)\* E X BI 1 (NE)\*

# Paralela

Nahrang Studio

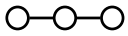

Collection composed of: modular and multidimensional suspensions, wall and ceiling lamps; floor and table lamps, made of glass.

## Horizontal suspension 36 3/4"

PARALELA HORIZONTAL SUSPENSION - GLASS TUBE 36 3/4" (DRIVER NOT INCLUDED)

Type	Article	Steel cable on connection point	Steel cable external cap	CCT	Electrical cable	Code	Size	Connection point	Colours	LED - Source
AC	TU	X without	C with	27 2700K	X without	X	LA 36 3/4"	1	BC white	~14,9W (~1103lm)
		C with		30 3000K	E with				ER earth red	
									GE greige	
									NE black	
									PG pine green limited edition	



DRY LOCATION CRI>90 24Vdc **LED**

example composition code AC TU C C (27)\* E X LA 1 (PG)\* ○ CCT and Colours have no impact on prices

lb 1.76 ft³ 0.21

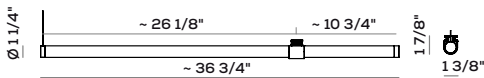

GLASS TUBE 36 3/4" + STEEL CABLE (118 1/8") + 1 CONNECTION POINT UP

example composition code AC TU X C (30)\* X X LA 1 (ER)\*

lb 2.20 ft³ 0.21

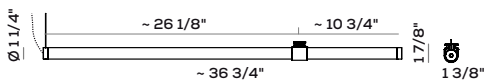

GLASS TUBE 36 3/4" + STEEL CABLE (118 1/8") + ELECTRICAL CABLE (157 1/2") + 1 CONNECTION POINT UP

example composition code AC TU X C (27)\* E X LA 1 (GE)\*

lb 1.76 ft³ 0.21

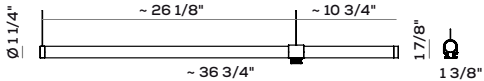

GLASS TUBE 36 3/4" + STEEL CABLE (118 1/8") ON CONNECTION POINT + STEEL CABLE (118 1/8") + 1 CONNECTION POINT

example composition code AC TU C C (30)\* X X LA 1 (PG)\*

lb 2.20 ft³ 0.21

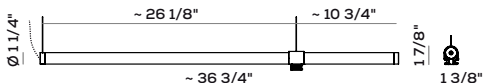

GLASS TUBE 36 3/4" + STEEL CABLE (118 1/8") ON CONNECTION POINT + STEEL CABLE (118 1/8") + ELECTRICAL CABLE (157 1/2") + 1 CONNECTION POINT

example composition code AC TU C C (27)\* E X LA 1 (NE)\*

# Paralela

Nahrang Studio

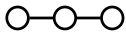

Collection composed of: modular and multidimensional suspensions, wall and ceiling lamps; floor and table lamps, made of glass.

## Horizontal suspension 46 3/4" - 2 connection points

PARALELA HORIZONTAL SUSPENSION - GLASS TUBE 46 3/4" 2 CONNECTION POINTS (DRIVER NOT INCLUDED)

Type	Article	Steel cable on connection point	Steel cable external cap	CCT	Electrical cable	Code	Size	Connection point	Colours	LED - Source
AC	TU	X without	X without	27 2700K	X without	X	BI 46 3/4"	2	BC white	~19W (~1418lm)
		C with		30 3000K					ER earth red	
									GE greige	
									NE black	
								PG pine green limited edition		



DRY LOCATION CR>90 24Vdc **LED**

example composition code AC TU X X (27)\* X X BI 2 (PG)\* ( )\* CCT and Colours have no impact on prices

lb 2.20 ft<sup>3</sup> 0.25

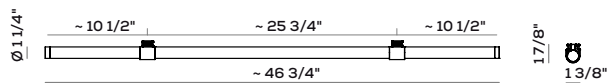

GLASS TUBE 46 3/4" + 2 CONNECTION POINTS UP

example composition code AC TU X X (27)\* X X BI 2 (BC)\*

lb 2.20 ft<sup>3</sup> 0.25

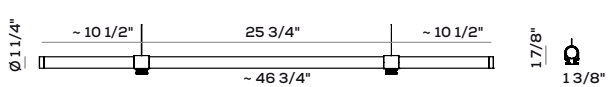

GLASS TUBE 46 3/4" + STEEL CABLES (118 1/8") ON CONNECTION POINTS + 2 CONNECTION POINTS

example composition code AC TU C X (30)\* X X BI 2 (ER)\*

# Paralela

Collection composed of: modular and multidimensional suspensions, wall and ceiling lamps; floor and table lamps, made of glass.

Nahtrang Studio

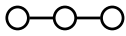

## HORIZONTAL SUSPENSION

### BELTS WITH MAGNETIC COVER

Big: lb 0.19 ft<sup>3</sup> 0.11

Small: lb 0.10 ft<sup>3</sup> 0.07

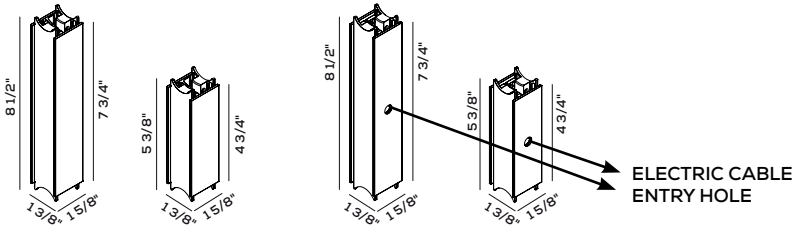

#### PARALELA HORIZONTAL SUSPENSION - BELT

Type	Article	Size	Electric cable entry	Typology variant	Code	Colours
AC	DIST	BI big  SM small	X without  F with	OR	XX	BC white  ER earth red  GE greige  NE black  PG pine green limited edition

example composition code AC DIST SM F OR XX BC

### END CUP WITH STEEL CABLE (118 1/8")

lb 0.04 ft<sup>3</sup> 0.04

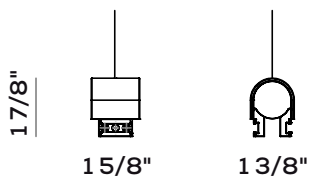

Code	Colours
ACTESTAC001XX	BC white  ER earth red  GE greige  NE black  PG pine green limited edition

Only for single suspension with 1 glass tube

example composition code ACTESTAC001XX BC

### ELECTRIC CABLES FOR BELT ENTRY

(FOR DC SECONDARY CIRCUIT)

lb 0.29 (2 poles) / 0.49 (4 poles)



Code	Poles	Colours
ACCAVOEL	2X001  4X001	BC white  NE black

example composition code ACCAVOEL 4X001 BC

Only for belt input, cable length 39 3/8"

# Paralela

Nahtrang Studio

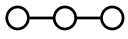

Collection composed of: modular and multidimensional suspensions, wall and ceiling lamps; floor and table lamps, made of glass.

## HORIZONTAL SUSPENSION

### CANOPY FOR RECESSED SYSTEM

(DRIVER NOT INCLUDED)

*lb 0,44*

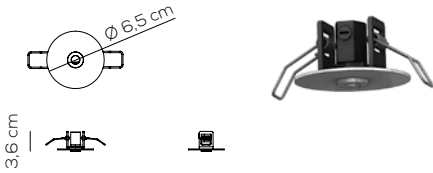

Code

ACCANOPYIN001

Colours

BC white

example composition code ACCANOPYIN001 BC

### CANOPY

(DRIVER NOT INCLUDED)

*lb 0.15 ft³ 0.14*

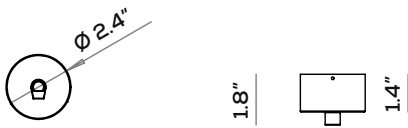

Code

ACCANOPYTO004

Colours

BC white

example composition code ACCANOPYTO004 BC

### COVER PLATED

(DRIVER NOT INCLUDED)

*lb 0.42 ft³ 0.14*

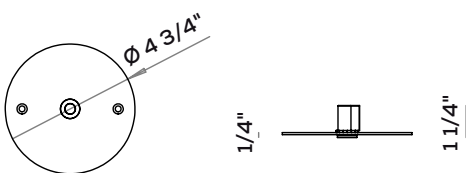

Code

ACCANOPYIN003

Colours

BC white

example composition code ACCANOPYIN003 BC

### CANOPY

(DRIVER NOT INCLUDED BUT CAN BE INSERT. COMPATIBLE DRIVERS: CEDMWC00206, CEDLTC00129)

*lb 3.31*

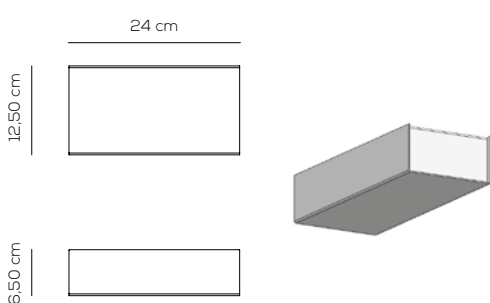

Code

ACCANOPYRE001

Colours

BC white

ER earth red

GE greige

NR black

PG pine green  
limited edition

example composition code ACCANOPYRE001 BC

# Paralela

Nahtrang Studio

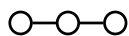

Collection composed of: modular and multidimensional suspensions, wall and ceiling lamps; floor and table lamps, made of glass.

## HORIZONTAL SUSPENSION

### CANOPY

(DRIVER NOT INCLUDED. 1 OR 2 DRIVERS CAN BE INSERTED)

*lb 5.51*

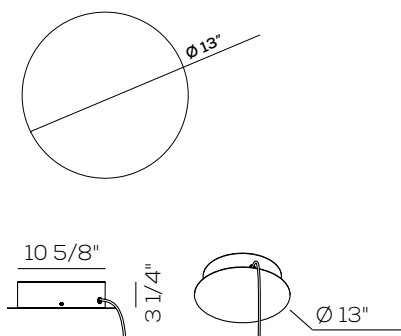

Code	Colours
ACCANOPYTO001	<b>BC</b> white
	<b>ER</b> earth red
	<b>GE</b> greige
	<b>NR</b> black
	<b>PG</b> pine green limited edition

example composition code ACCANOPYTO001 ER

# Paralela

Nahtrang Studio

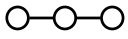

Collection composed of: modular and multidimensional suspensions, wall and ceiling lamps; floor and table lamps, made of glass.

## Horizontal suspension

Compositional examples with 1 glass tube (CANOPY AND DRIVER ARE NOT INCLUDED)

CCT 3000K - color white

HORIZONTAL 1



ACTUXC30EXLA1BC + ACTESTAC001XXBC + ACDISTSMMORXXBC

Code variant with electric cable entry from belt

ACTUXC30XXLA1BC + ACTESTAC001XXBC + ACDISTSMMFORXXBC + ACCAVOEL2X001BC (118 1/8")

HORIZONTAL 2

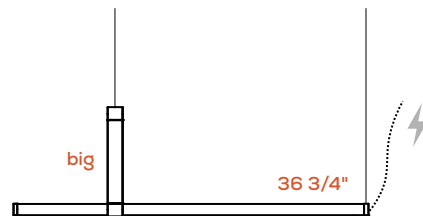

ACTUXC30EXLA1BC + ACTESTAC001XXBC + ACDISTBIXORXXBC

Code variant with electric cable entry from belt

ACTUXC30XXLA1BC + ACTESTAC001XXBC + ACDISTBIFORXXBC + ACCAVOEL2X001BC (118 1/8")

HORIZONTAL 3



ACTUXC30EXBI1BC + ACTESTAC001XXBC + ACDISTSMMORXXBC

Code variant with electric cable entry from belt

ACTUXC30XXBI1BC + ACTESTAC001XXBC + ACDISTSMMFORXXBC + ACCAVOEL2X001BC (118 1/8")

HORIZONTAL 4



ACTUXC30EXBI1BC + ACTESTAC001XXBC + ACDISTBIXORXXBC

Code variant with electric cable entry from belt

ACTUXC30XXBI1BC + ACTESTAC001XXBC + ACDISTBIFORXXBC + ACCAVOEL2X001BC (118 1/8")



# Paralela

Nahtrang Studio

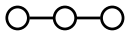

Collection composed of: modular and multidimensional suspensions, wall and ceiling lamps; floor and table lamps, made of glass.

## Horizontal suspension

Compositional examples with 2 glass tubes (CANOPY AND DRIVER ARE NOT INCLUDED)

CCT 3000K - color white

HORIZONTAL 5

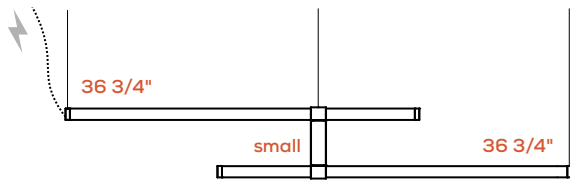

ACTUCC30EXLA1BC + ACDISTSMXORXXBC + ACTUXC30XXLA1BC

Code variant with electric cable entry from belt

ACTUCC30XXLA1BC + ACDISTSMFORXXBC + ACTUXC30XXLA1BC + ACCAVOEL2X001BC (118 1/8")

HORIZONTAL 6

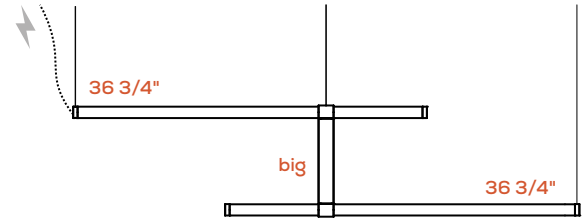

ACTUCC30EXLA1BC + ACDISTBIXORXXBC + ACTUXC30XXLA1BC

Code variant with electric cable entry from belt

ACTUCC30XXLA1BC + ACDISTBIFORXXBC + ACTUXC30XXLA1BC + ACCAVOEL2X001BC (118 1/8")

HORIZONTAL 7

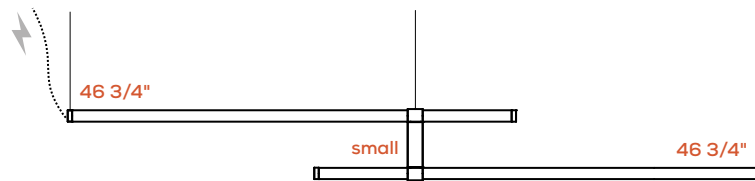

ACTUCC30EXBI1BC + ACDISTSMXORXXBC + ACTUXC30XXBI1BC

Code variant with electric cable entry from belt

ACTUCC30XXBI1BC + ACDISTSMFORXXBC + ACTUXC30XXBI1BC + ACCAVOEL2X001BC (118 1/8")

HORIZONTAL 8

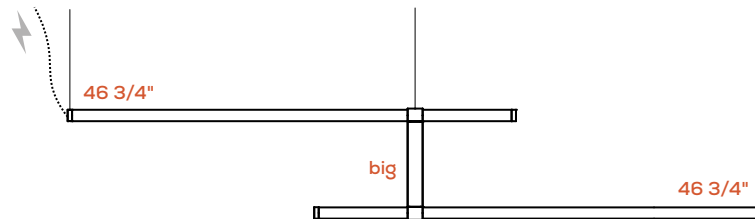

ACTUCC30EXBI1BC + ACDISTBIXORXXBC + ACTUXC30XXBI1BC

Code variant with electric cable entry from belt

ACTUCC30XXBI1BC + ACDISTBIFORXXBC + ACTUXC30XXBI1BC + ACCAVOEL2X001BC (118 1/8")

HORIZONTAL 9

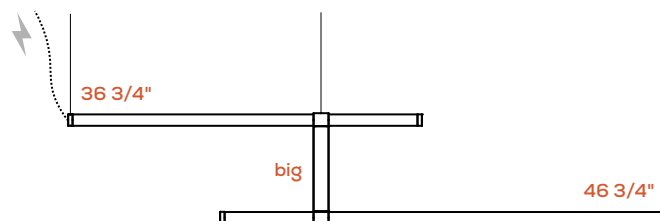

ACTUCC30EXLA1BC + ACDISTBIXORXXBC + ACTUXC30XXBI1BC

Code variant with electric cable entry from belt

ACTUCC30XXLA1BC + ACDISTBIFORXXBC + ACTUXC30XXBI1BC + ACCAVOEL2X001BC (118 1/8")

# Paralela

Nahtrang Studio

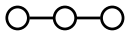

Collection composed of: modular and multidimensional suspensions, wall and ceiling lamps; floor and table lamps, made of glass.

## Horizontal suspension

**Compositional examples with 3 glass tubes** (CANOPY AND DRIVER ARE NOT INCLUDED)

**CCT 3000K - color white**

HORIZONTAL 10

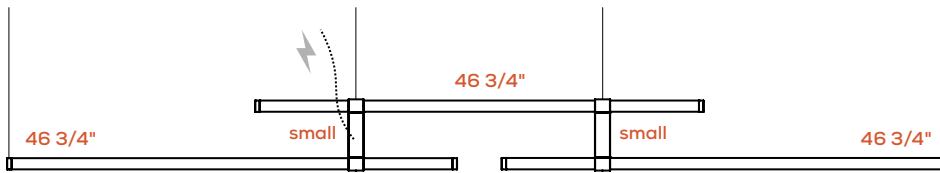

ACTUXC30XXBI1BC + ACDISTSMFORXXBC + ACTUCX30XXBI2BC + ACDISTSMXORXXBC + ACTUXC30XXBI1BC + ACCAVOEL4X001BC (118 1/8")

You can choose which belt will have the electric cable (4-pole cable) entry

HORIZONTAL 11

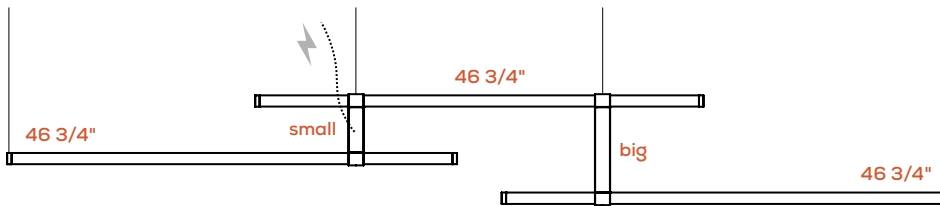

ACTUCC30XXBI1BC + ACDISTSMFORXXBC + ACTUCX30XXBI2BC + ACDISTBIXORXXBC + ACTUCC30XXBI1BC + ACCAVOEL4X001BC (118 1/8")

You can choose which belt will have the electric cable (4-pole cable) entry

HORIZONTAL 12

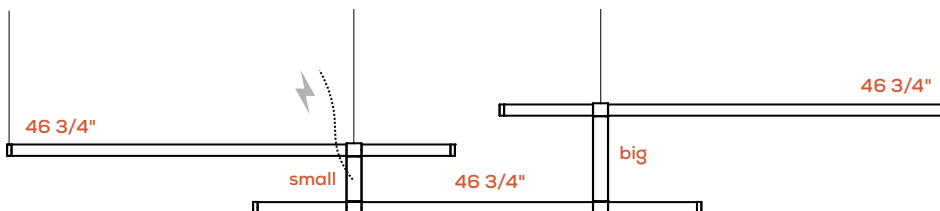

ACTUCC30XXBI1BC + ACDISTSMFORXXBC + ACTUXX30XXBI2BC + ACDISTBIXORXXBC + ACTUCC30XXBI1BC + ACCAVOEL4X001BC (118 1/8")

You can choose which belt will have the electric cable (4-pole cable) entry

HORIZONTAL 13

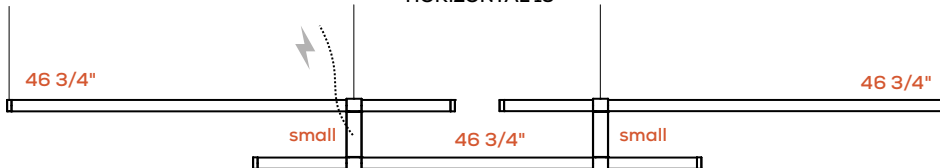

ACTUCC30XXBI1BC + ACDISTSMFORXXBC + ACTUXX30XXBI2BC + ACDISTSMXORXXBC + ACTUCC30XXBI1BC + ACCAVOEL4X001BC (118 1/8")

You can choose which belt will have the electric cable (4-pole cable) entry

# Paralela

Nahtrang Studio

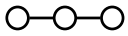

Collection composed of: modular and multidimensional suspensions, wall and ceiling lamps; floor and table lamps, made of glass.

## Horizontal suspension

**Compositional examples with 3 glass tubes** (CANOPY AND DRIVER ARE NOT INCLUDED)

**CCT 3000K - color white**

HORIZONTAL 14

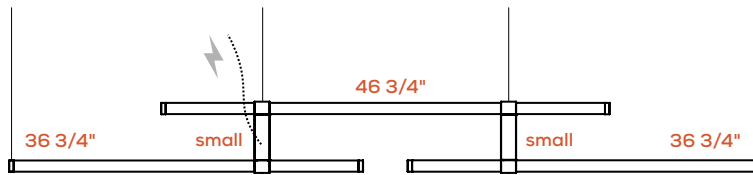

ACTUXC30XXLA1BC + ACDISTSMFORXXBC + ACTUCX30XXBI2BC + ACDISTSMXORXXBC + ACTUXC30XXLA1BC + ACCAVOEL4X001BC (118 1/8")

You can choose which belt will have the electric cable (4-pole cable) entry

HORIZONTAL 15

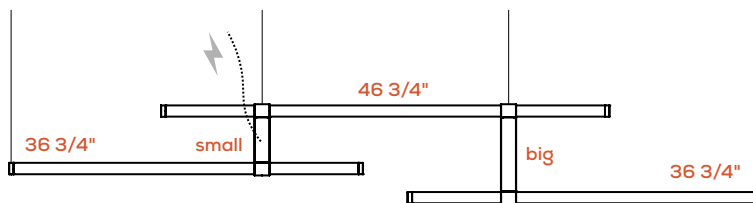

ACTUXC30XXLA1BC + ACDISTSMFORXXBC + ACTUCX30XXBI2BC + ACDISTBIXORXXBC + ACTUXC30XXLA1BC + ACCAVOEL4X001BC (118 1/8")

You can choose which belt will have the electric cable (4-pole cable) entry

HORIZONTAL 16

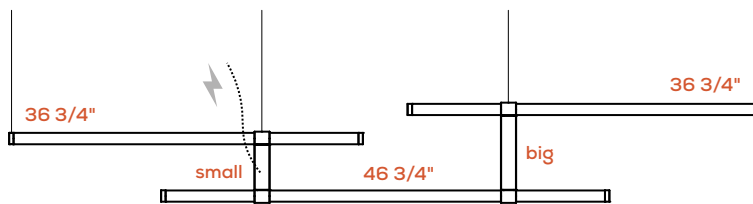

ACTUCC30XXLA1BC + ACDISTSMFORXXBC + ACTUXX30XXBI2BC + ACDISTBIXORXXBC + ACTUCC30XXLA1BC + ACCAVOEL4X001BC (118 1/8")

You can choose which belt will have the electric cable (4-pole cable) entry

HORIZONTAL 17

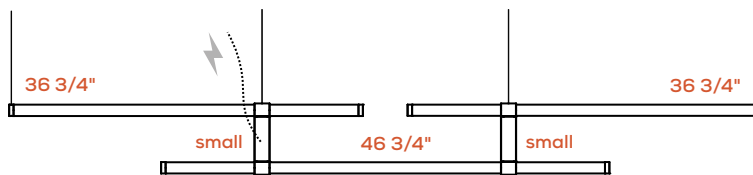

ACTUCC30XXLA1BC + ACDISTSMFORXXBC + ACTUXX30XXBI2BC + ACDISTSMXORXXBC + ACTUCC30XXLA1BC + ACCAVOEL4X001BC (118 1/8")

You can choose which belt will have the electric cable (4-pole cable) entry

# Paralela

Nahtrang Studio

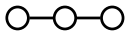

Collection composed of: modular and multidimensional suspensions, wall and ceiling lamps; floor and table lamps, made of glass.

## Horizontal suspension

Compositional examples with 4 glass tubes (CANOPY AND DRIVER ARE NOT INCLUDED)

CCT 3000K - color white

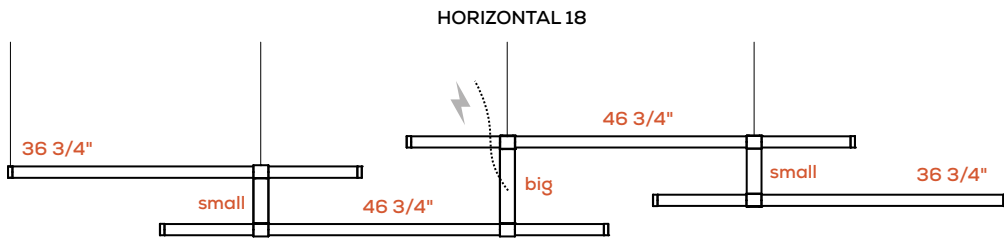

ACTUCC30XXLA1BC + ACDISTSXMORXXBC + ACTUXX30XXBI2BC + ACDISTBIFORXXBC +  
ACTUCX30XXBI2BC + ACDISTSXMORXXBC + ACTUXC30XXLA1BC + ACCAVOEL4X001BC (118 1/8")

The electric cable (4-pole cable) entry must only be in the central belt

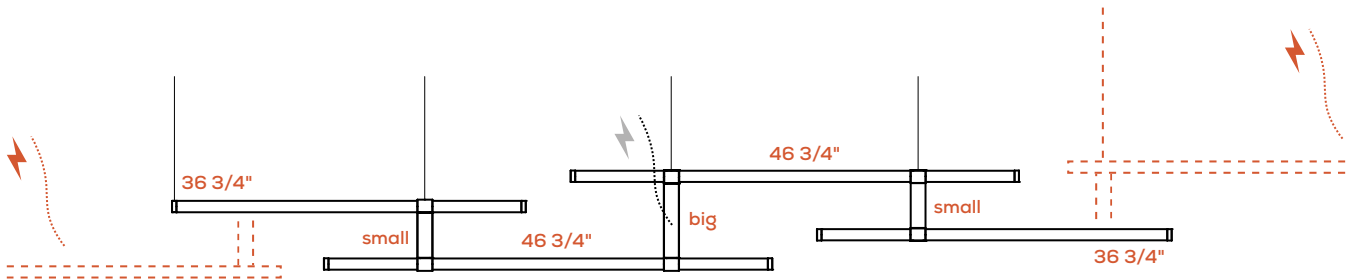

----- ATTENTION -----

Up to 4 glass tubes can be powered with the quadripolar electric cable.  
In the case of more extensive compositions, it will be necessary to add further electrical connections

# Paralela

Nahtrang Studio

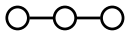

Collection composed of: modular and multidimensional suspensions, wall and ceiling lamps; floor and table lamps, made of glass.

## Vertical suspension 23 3/4" - 36 3/4"

### PARALELA VERTICAL SUSPENSION - GLASS TUBE (DRIVER NOT INCLUDED)

Type	Article	Code	Code	CCT	Electrical cable	Code	Size	Code	Colours	LED - Source
AC	TU	X	X	27 2700K	E	X	SM 23 3/4"	X	BC white	~9,2W (~681lm)
				30 3000K			LA 36 3/4"		ER earth red	~14,9W (~1103lm)
									GE greige	
									NE black	
									PG pine green limited edition	



dimmable  
with dedicated PSU

DRY LOCATION CRI>90 24Vdc **LED**

example composition code AC TU X X (30)\* E X SM X (GE)\* ( )\* CCT and Colours have no impact on prices

lb 1.10 ft<sup>3</sup> 0.12

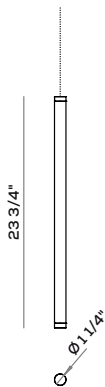

GLASS TUBE 23 3/4" + ELECTRICAL CABLE (98.4")

example composition code AC TU X X (27)\* E X SM X (BC)\*

lb 1.76 ft<sup>3</sup> 0.21



GLASS TUBE 36 3/4" + ELECTRICAL CABLE (98.4")

example composition code AC TU X X (30)\* E X LA X (GE)\*

# Paralela

Nahtrang Studio

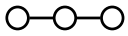

Collection composed of: modular and multidimensional suspensions, wall and ceiling lamps; floor and table lamps, made of glass.

## VERTICAL SUSPENSION

### BELTS

Big: lb 0.19 ft<sup>3</sup> 0.11

Small: lb 0.10 ft<sup>3</sup> 0.07

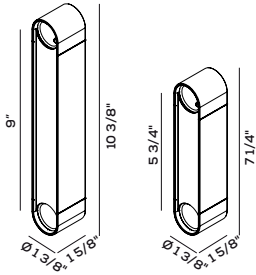

#### PARALELA VERTICAL SUSPENSION - BELT

Type	Article	Size	Electric cable entry	Typology variant	Code	Colours
AC	DIST	BI* big  SM small	X without	VE	XX	BC white  ER earth red  GE greige  NE black  PG pine green limited edition

example composition code AC DIST BI X VE XX ER

\* Belt big not applicable with Canopy 2 and Canopy 3

## CANOPY FOR RECESSED SYSTEM

(DRIVER NOT INCLUDED)

lb 0.44

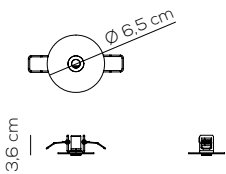

Code

ACCANOPYIN001

Colours

BC white

example composition code ACCANOPYIN001 BC

## CANOPY

(DRIVER NOT INCLUDED)

lb 0.15 ft<sup>3</sup> 0.14

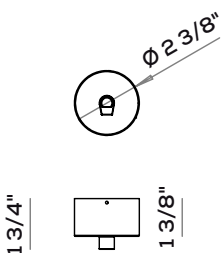

Code

ACCANOPYTO004

Colours

BC white

example composition code ACCANOPYTO004 BC

# Paralela

Nahtrang Studio

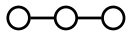

Collection composed of: modular and multidimensional suspensions, wall and ceiling lamps; floor and table lamps, made of glass.

## VERTICAL SUSPENSION

### COVER PLATED

(DRIVER NOT INCLUDED)

lb 0.42 ft<sup>3</sup> 0.14

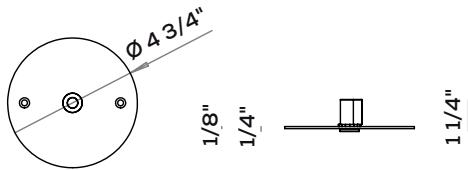

Code

ACCANOPYIN003

Colours

BC white

example composition code ACCANOPYIN003 BC

### CANOPY 2

(DRIVER NOT INCLUDED BUT CAN BE INSERT)

lb 1.98 ft<sup>3</sup> 0.88

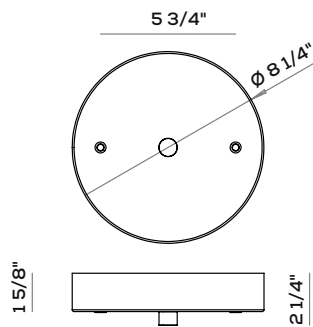

Code

ACCANOPYTO002

Colours

BC white

ER earth red

GE greige

NE black

PG pine green  
limited edition

example composition code ACCANOPYTO002 BC

### CANOPY 3

(DRIVER NOT INCLUDED BUT CAN BE INSERT)

lb 1.98 ft<sup>3</sup> 0.88

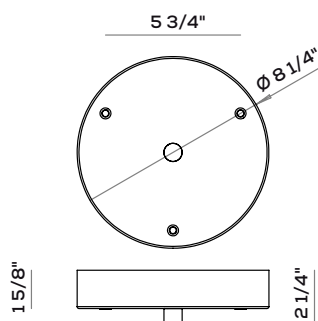

Code

ACCANOPYTO003

Colours

BC white

ER earth red

GE greige

NE black

PG pine green  
limited edition

example composition code ACCANOPYTO003 ER

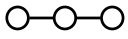

## Vertical suspension

### Compositional examples with 1, 2 and 3 glass tubes (CANOPY AND DRIVER ARE NOT INCLUDED) CCT 3000K - color white

VERTICAL 1

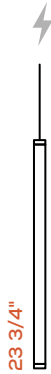

ACTUXX30EXSMXBC

VERTICAL 2

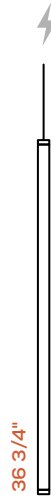

ACTUXX30EXLAXBC

VERTICAL 3

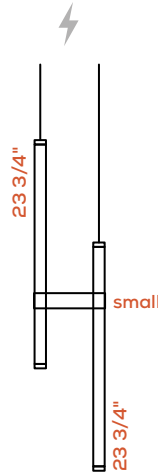

ACTUXX30EXSMXBC  
ACDISTSMXVEXXBC  
ACTUXX30EXSMXBC

VERTICAL 4

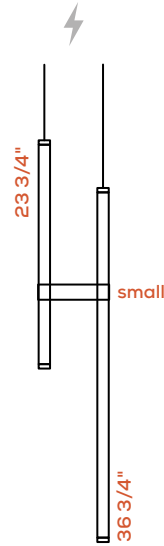

ACTUXX30EXSMXBC  
ACDISTSMXVEXXBC  
ACTUXX30EXLAXBC

VERTICAL 5

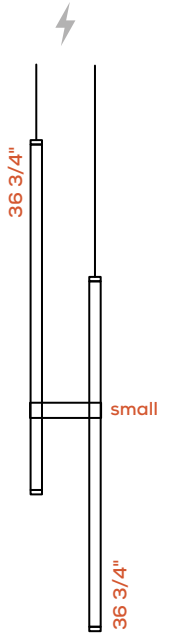

ACTUXX30EXLAXBC  
ACDISTSMXVEXXBC  
ACTUXX30EXLAXBC

VERTICAL 6

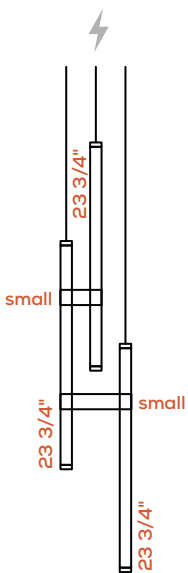

ACTUXX30EXSMXBC  
ACDISTSMXVEXXBC  
ACTUXX30EXSMXBC  
ACDISTSMXVEXXBC  
ACTUXX30EXSMXBC

VERTICAL 7

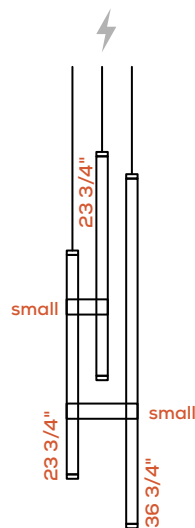

ACTUXX30EXSMXBC  
ACDISTSMXVEXXBC  
ACTUXX30EXSMXBC  
ACDISTSMXVEXXBC  
ACTUXX30EXLAXBC

VERTICAL 8

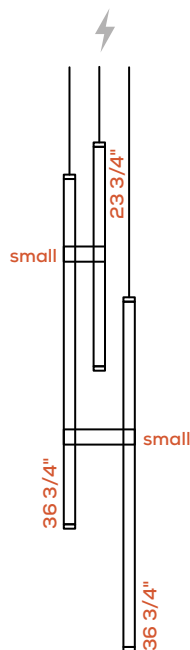

ACTUXX30EXSMXBC  
ACDISTSMXVEXXBC  
ACTUXX30EXLAXBC  
ACDISTSMXVEXXBC  
ACTUXX30EXLAXBC

VERTICAL 9

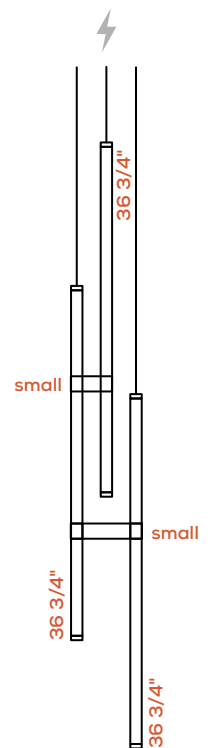

ACTUXX30EXLAXBC  
ACDISTSMXVEXXBC  
ACTUXX30EXLAXBC  
ACDISTSMXVEXXBC  
ACTUXX30EXLAXBC



# Paralela

Nahtrang Studio

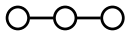

Collection composed of: modular and multidimensional suspensions, wall and ceiling lamps; floor and table lamps, made of glass.

## Vertical suspension

Compositional examples with more than 3 glass tubes (CANOPY AND DRIVER ARE NOT INCLUDED)

CCT 3000K - color white

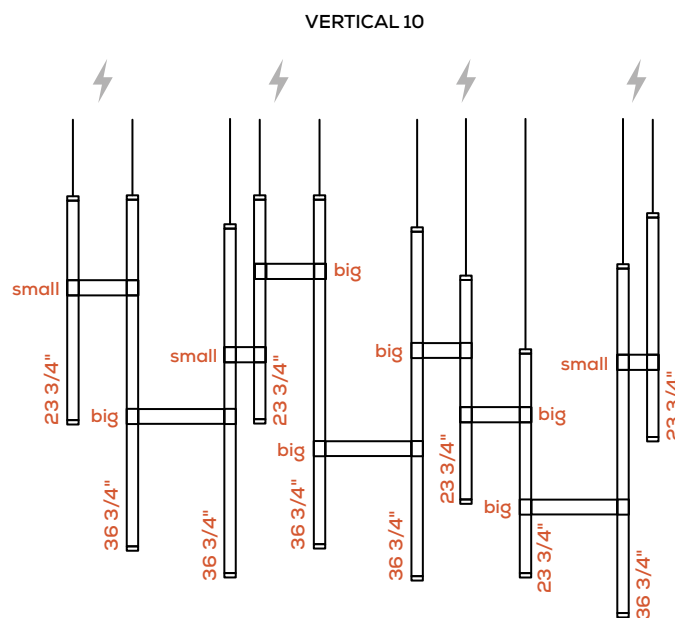

ACTUXX30EXSMXBC + ACDISTSMXVEXXBC + ACTUXX30EXLAXBC + ACDISTBIXVEXXBC + ACTUXX30EXLAXBC + ACDISTSMXVEXXBC +  
ACTUXX30EXSMXBC + ACDISTBIXVEXXBC + ACTUXX30EXLAXBC + ACDISTBIXVEXXBC + ACTUXX30EXLAXBC + ACDISTBIXVEXXBC +  
ACTUXX30EXSMXBC + ACDISTBIXVEXXBC + ACTUXX30EXSMXBC + ACDISTBIXVEXXBC + ACTUXX30EXLAXBC + ACDISTSMXVEXXBC + ACTUXX30EXSMXBC

# Paralela

Nahrang Studio

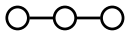

Collection composed of: modular and multidimensional suspensions, wall and ceiling lamps; floor and table lamps, made of glass.

## Wall and ceiling

11 3/4" - 36 3/4" - 46 3/4"

### PARALELA WALL - GLASS TUBE (DRIVER NOT INCLUDED)

Type	Article	Code	Code	CCT	Code	Code	Size	Connection point	Colours	LED - Source
AC	TU	X	X	27 2700K	X	X	MI 11 3/4"	1	BC white	~4W (~315lm)
				30 3000K			LA 36 3/4"	2	ER earth red	~14,9W (~1103lm)
							BI 46 3/4"		GE greige NE black PG pine green limited edition	~19W (~1418lm)



DRY LOCATION CRI>90 24Vdc **LED**

example composition code AC TU X X **(30)** X X BI 1 **(NE)** CCT and Colours have no impact on prices

lb 0.66 ft<sup>3</sup> 0.06

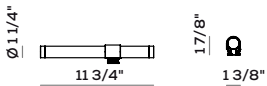

GLASS TUBE 11 3/4" + 1 CONNECTION POINT

example composition code AC TU X X **(27)** X X MI 1 **(BC)**

lb 1.76 ft<sup>3</sup> 0.21

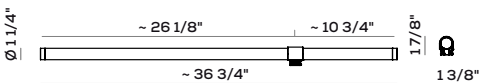

GLASS TUBE 36 3/4" + 1 CONNECTION POINT

example composition code AC TU X X **(30)** X X LA 1 **(GE)**

lb 2.20 ft<sup>3</sup> 0.5

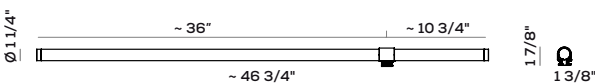

GLASS TUBE 46 3/4" + 1 CONNECTION POINT

example composition code AC TU X X **(27)** X X BI 1 **(PG)**

lb 2.20 ft<sup>3</sup> 0.25

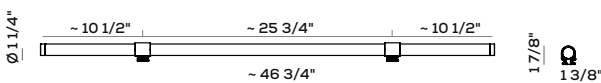

GLASS TUBE 46 3/4" + 2 CONNECTION POINTS

example composition code AC TU X X **(27)** X X BI 2 **(BC)**

# Paralela

Nahrang Studio

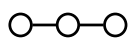

Collection composed of: modular and multidimensional suspensions, wall and ceiling lamps; floor and table lamps, made of glass.

## WALL AND CEILING

### BELTS WITH MAGNETIC COVER

Small: lb 0.10 ft<sup>3</sup> 0.07

Mini: lb 0.04 ft<sup>3</sup> 0.04

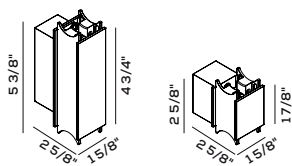

#### PARALELA WALL - BELT

Type	Article	Size	Code	Variant typology	Code	Colours
AC	DIST	SM small  MI mini	X	AP	XX	BC white  ER earth red  GE greige  NE black  PG pine green limited edition

example composition code AC DIST MI X AP XX NE

\*\*Mud kit not included.

## STIRRUP

lb 0.04 ft<sup>3</sup> 0.04

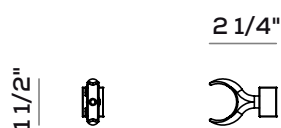

Code	Colours
ACSTAFFA001XX	BC white  ER earth red  GE greige  NE black  PG pine green limited edition

Only for glass tube LA 36 3/4" and BI 46 3/4"

example composition code ACSTAFFA001XX BC

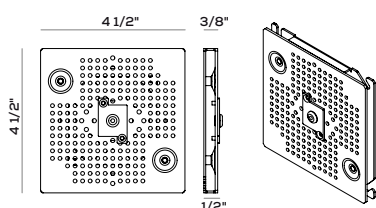

### MUD KIT (For ACDISTSM and ACDISTMI)

ACMUDKITUN001XX

Installation accessory for wall and ceiling lamps

# Paralela

Nahrang Studio

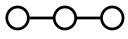

Collection composed of: modular and multidimensional suspensions, wall and ceiling lamps; floor and table lamps, made of glass.

## Wall and ceiling

Compositional examples with 2 glass tubes (DRIVER NOT INCLUDED)

CCT 3000K - color white

WALL 1

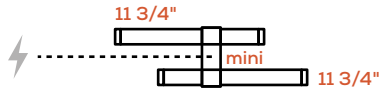

ACTUX30XXMI1BC + ACDISTMIXAPXXBC + ACTUX30XXMI1BC

WALL 2

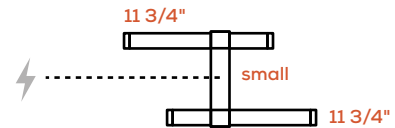

ACTUX30XXMI1BC + ACDISTSXAPXXBC + ACTUX30XXMI1BC

WALL 3



ACTUX30XXMI1BC + ACDISTMIXAPXXBC + ACTUX30XXLA1BC  
+ ACSTAFFA001XXBC

WALL 4

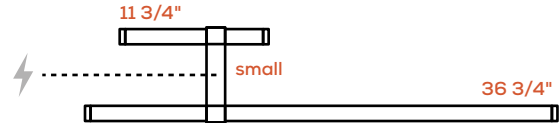

ACTUX30XXMI1BC + ACDISTSXAPXXBC + ACTUX30XXLA1BC  
+ ACSTAFFA001XXBC

WALL 5

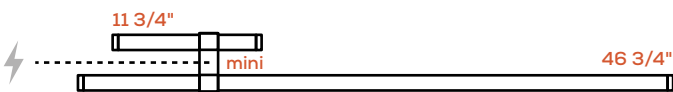

ACTUX30XXMI1BC + ACDISTMIXAPXXBC + ACTUX30XXBI1BC  
+ ACSTAFFA001XXBC

WALL 6



ACTUX30XXMI1BC + ACDISTSXAPXXBC + ACTUX30XXBI1BC  
+ ACSTAFFA001XXBC

WALL 7



ACTUX30XXLA1BC + ACDISTMIXAPXXBC + ACTUX30XXLA1BC  
+ 2 X ACSTAFFA001XXBC

WALL 8

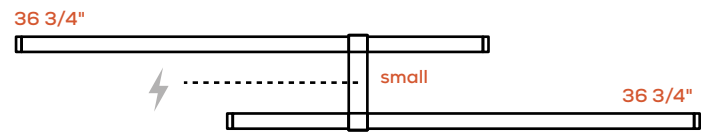

ACTUX30XXLA1BC + ACDISTSXAPXXBC + ACTUX30XXLA1BC  
+ 2 X ACSTAFFA001XXBC

# Paralela

Nahtrang Studio

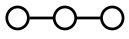

Collection composed of: modular and multidimensional suspensions, wall and ceiling lamps; floor and table lamps, made of glass.

## Wall and ceiling

Compositional examples with 2 glass tubes (DRIVER NOT INCLUDED)

CCT 3000K - color white

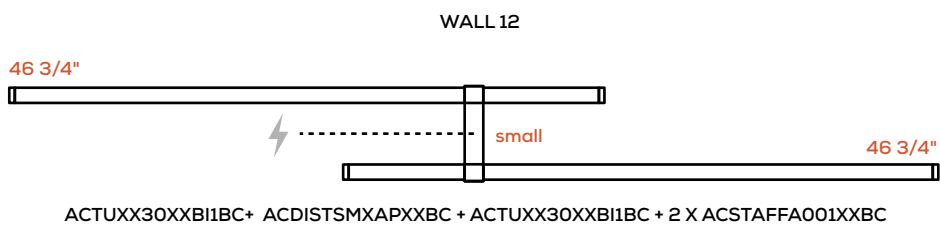
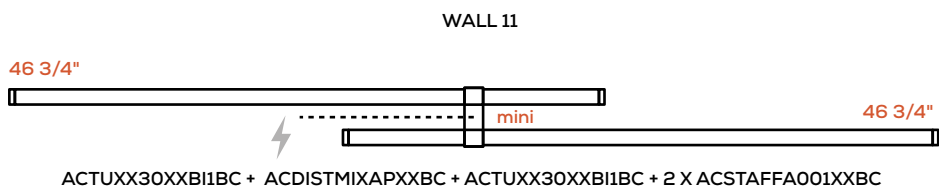
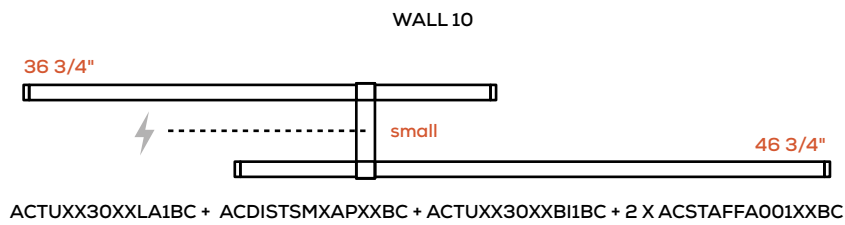
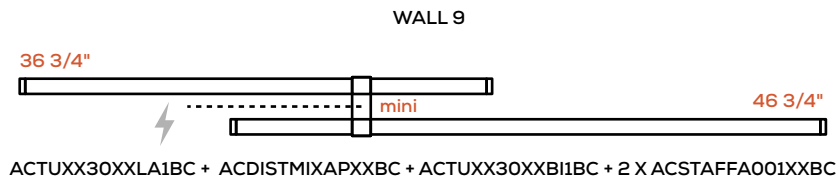

# Paralela

Nahrang Studio

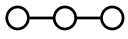

Collection composed of: modular and multidimensional suspensions, wall and ceiling lamps; floor and table lamps, made of glass.

## Wall and ceiling

Compositional examples with 3 glass tubes (DRIVER NOT INCLUDED)

CCT 3000K - color white

WALL 13

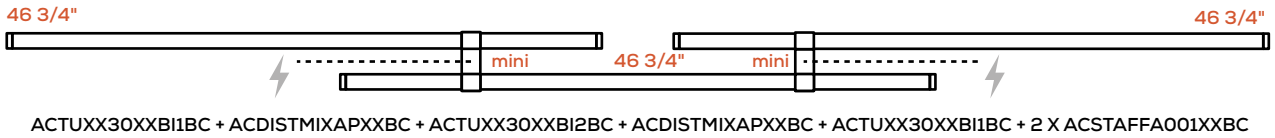

ACTUXX30XXBI1BC + ACDISTMIXAPXXBC + ACTUXX30XXBI2BC + ACDISTMIXAPXXBC + ACTUXX30XXBI1BC + 2 X ACSTAFFA001XXBC

WALL 14

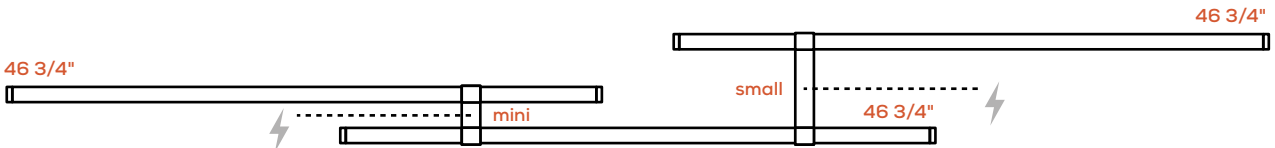

ACTUXX30XXBI1BC + ACDISTMIXAPXXBC + ACTUXX30XXBI2BC + ACDISTSXAPXXBC + ACTUXX30XXBI1BC + 2 X ACSTAFFA001XXBC

WALL 15

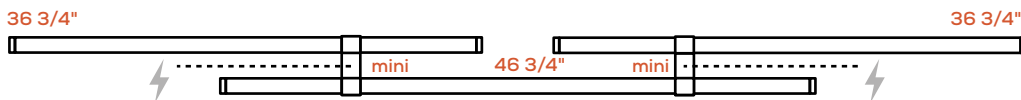

ACTUXX30XXLA1BC + ACDISTMIXAPXXBC + ACTUXX30XXBI2BC + ACDISTMIXAPXXBC + ACTUXX30XXLA1BC + 2 X ACSTAFFA001XXBC

WALL 16

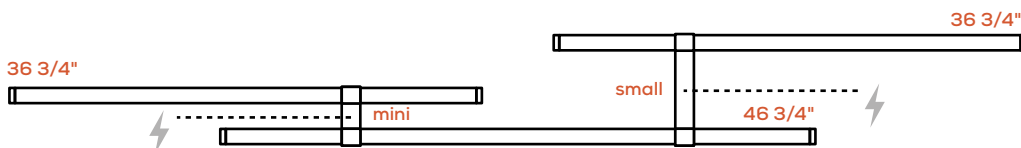

ACTUXX30XXLA1BC + ACDISTMIXAPXXBC + ACTUXX30XXBI2BC + ACDISTSXAPXXBC + ACTUXX30XXLA1BC + 2 X ACSTAFFA001XXBC

WALL 17

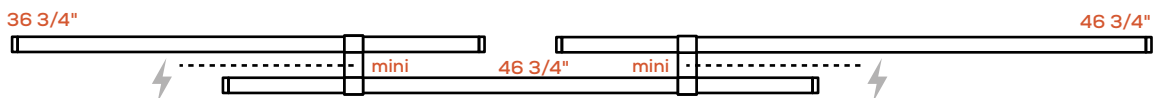

ACTUXX30XXLA1BC + ACDISTMIXAPXXBC + ACTUXX30XXBI2BC + ACDISTMIXAPXXBC + ACTUXX30XXBI1BC + 2 X ACSTAFFA001XXBC

WALL 18



ACTUXX30XXLA1BC + ACDISTMIXAPXXBC + ACTUXX30XXBI2BC + ACDISTSXAPXXBC + ACTUXX30XXBI1BC + 2 X ACSTAFFA001XXBC

# Paralela

Nahtrang Studio

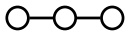

Collection composed of: modular and multidimensional suspensions, wall and ceiling lamps; floor and table lamps, made of glass.

## Wall and ceiling

Compositional examples with 4 glass tubes (DRIVER NOT INCLUDED)

CCT 3000K - color white

WALL 19

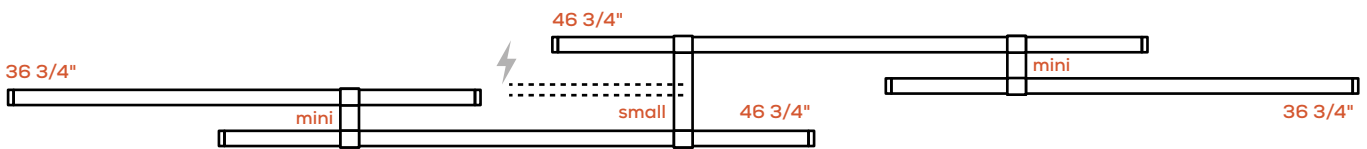

ACTUXX30XXLA1BC + ACDISTMIXAPXXBC + ACTUXX30XXBI2BC+ ACDISTSXAPXXBC + ACTUXX30XXBI2BC + ACDISTMIXAPXXBC  
+ ACTUXX30XXLA1BC + 2 X ACSTAFFA001XXBC

The electric cable (4-pole cable) entry must only be in the central belt

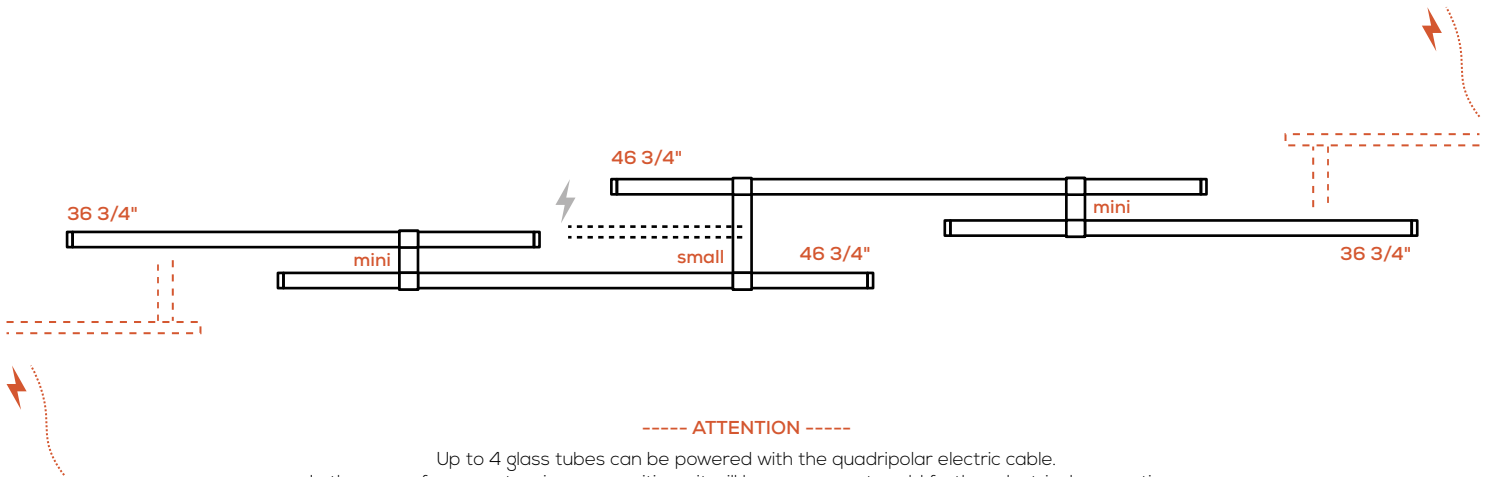

----- ATTENTION -----

Up to 4 glass tubes can be powered with the quadripolar electric cable.  
In the case of more extensive compositions, it will be necessary to add further electrical connections

# Paralela

Nahrang Studio

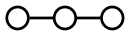

Collection composed of: modular and multidimensional suspensions, wall and ceiling lamps; floor and table lamps, made of glass.

## Dimmable 1-10V

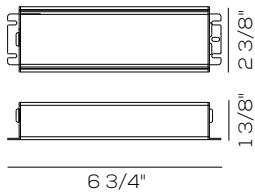

DRIVER 24V

Code	Product	W Max	Input	Output	Weight
CEDMWC00206	Dimmable 1-10V	40	100-305Vac 50-60 Hz	24VDC constant 3,2A	net lb 1.76



Suitable for: ACTUXXXXXBIXXX, ACTUXXXXXLAXXX, ACTUXXXXXMIXXX  
Remot position or inside an accessory canopy. Casambi compatible.

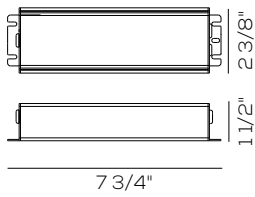

DRIVER 24V

Code	Product	W Max	Input	Output	Weight
CEDMWC00202	Dimmable 1-10V	80	100-305Vac 50-60 Hz	24VDC constant 3,4A	net lb 1.98



Suitable for: ACTUXXXXXBIXXX, ACTUXXXXXLAXXX  
Remot position or inside an accessory canopy. Casambi compatible.

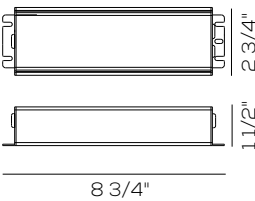

DRIVER 24V

Code	Product	W Max	Input	Output	Weight
CEDMWC00203	Dimmable 1-10V	100	100-305Vac 50-60 Hz	24VDC constant 4A	net lb 2.64



Suitable for: ACTUXXXXXBIXXX  
Remot position or inside an accessory canopy. Casambi compatible.

## Dimmable DALI

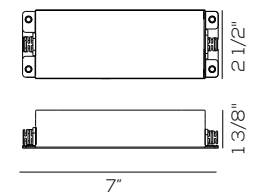

DRIVER 24V

Code	Product	W Max	Input	Output	Weight
CEDMWC00204	Dimmable DALI	75	100-305Vac 50-60 Hz	24VDC constant 3,15A	net lb 1.76



Suitable for: ACTUXXXXXBIXXX, ACTUXXXXXLAXXX, ACTUXXXXXSMIXXX  
Remot position or inside an accessory canopy. Casambi compatible.

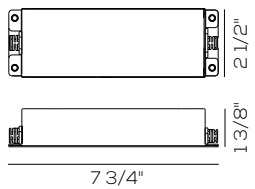

DRIVER 24V

Code	Product	W Max	Input	Output	Weight
CEDMWC00205	Dimmable DALI	100	100-305Vac 50-60 Hz	24VDC constant 4A	net lb 1.87

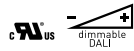

Suitable for: ACTUXXXXXBIXXX  
Remot position or inside an accessory canopy. Casambi compatible.

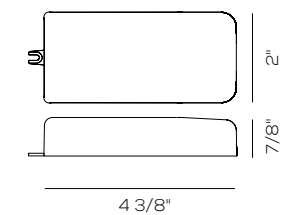

DRIVER 24V

Code	Product	W Max	Input	Output	Weight
CEDLTC00126	Dimmable DALI	15	110-240Vac 50-60 Hz	24VDC	net lb 0.233

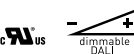

Suitable for: ACTUXXXXXLAXXX, ACTUXXXXXSMIXXX, ACTUXXXXXMIXXX  
Remot position or inside an accessory canopy. Casambi compatible.



# Paralela

Nahtrang Studio

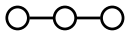

Collection composed of: modular and multidimensional suspensions, wall and ceiling lamps; floor and table lamps, made of glass.

## Dimmable 0/1-10V

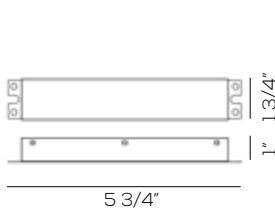

DRIVER 24V

Code	Product	W Max	Input	Output	Weight
CEDLTC00129	Dimmable 0/1-10V	60	120-277Vac 50-60 Hz	24VDC constant 2,5A	net lb 0.75

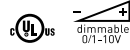

Suitable for: ACTUXXXXXXBIXXX, ACTUXXXXXXLAXXX, ACTUXXXXXXSMXXX, ACTUXXXXXXMIXXX  
Remot position or inside an accessory canopy. Casambi compatible.

## Dimmable 0/1-10V - Push

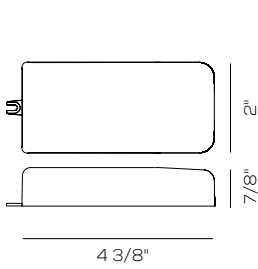

DRIVER 24V

Code	Product	W Max	Input	Output	Weight
CEDLTC00132	Dimmable 0/1-10V, PUSH	15	110-240Vac 50-60 Hz	24 Vdc	net lb 0.25

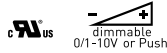

Suitable for: ACTUXXXXXXLAXXX, ACTUXXXXXXSMXXX, ACTUXXXXXXMIXXX  
Remot position or inside an accessory canopy. Casambi compatible.

## Dimmable Triac/ELV/0-10V

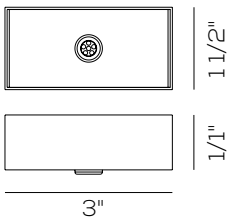

DRIVER 24V

Code	Product	W Max	Input	Output	Weight
CEDLTF00600	Dimmable Triac/ELV/0-10V	25	120-277Vac 50-60 Hz	24VDC constant 1,1A	net lb 0,30



Suitable for: ACTUXXXXXXBIXXX, ACTUXXXXXXLAXXX, ACTUXXXXXXSMXXX, ACTUXXXXXXMIXXX  
Remot position or inside an accessory canopy. Suitable for J-Box. Casambi compatible.

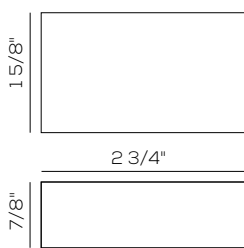

DRIVER 24V

Code	Product	W Max	Input	Output	Weight
CEDLTF00601	Dimmable Triac/ELV/0-10V	12	120-277Vac 50-60 Hz	24 Vdc	net lb 0.317



Suitable for: ACTUXXXXXXLAXXX, ACTUXXXXXXSMXXX, ACTUXXXXXXMIXXX  
Remot position or inside an accessory canopy. Suitable for J-Box. Casambi compatible.

# Paralela

Nahrang Studio

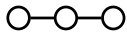

Collection composed of: modular and multidimensional suspensions, wall and ceiling lamps; floor and table lamps, made of glass.

## FLOOR LAMP

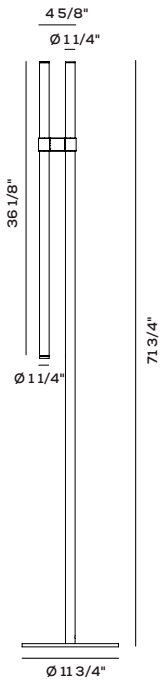

### PARALELA FLOOR LAMP

Type	Article	CCT	Code	Colours	LED - Source
PT	PARALELA	27 2700K	X	BC white	~14,9W (~1103lm)
		30 3000K		ER earth red	
				GE greige	
				NE black	
				PG pine green limited edition	



DRY LOCATION CRI>90 24Vdc **LED**

example composition code PT PARALELA 30 X GE

\* Power and control equipment not included

## TABLE LAMP

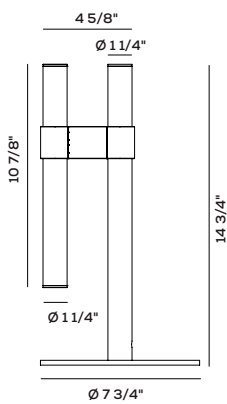

### PARALELA TABLE LAMP

Type	Article	CCT	Code	Colours	LED - Source
LT	PARALELA	27 2700K	X	BC white	~4W (~315lm)
		30 3000K		ER earth red	
				GE greige	
				NE black	
				PG pine green limited edition	



DRY LOCATION CRI>90 24Vdc **LED**

example composition code LT PARALELA 27 X PG

\* Power and control equipment not included

## POWER AND CONTROL EQUIPMENT

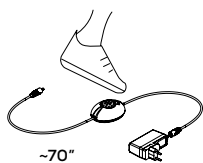

ACCONTROLPT0001

**Power and control equipment (dimmer, driver, cables, plug)**  
100-240Vac input, 25W, 24Vdc output  
Plugs: EU, USA (Japan), UK, CCC  
Color: black

Recommended for floor lamp, can also be used for table lamp

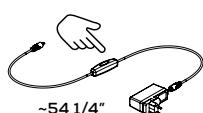

ACCONTROLLT0001

**Power and control equipment (dimmer, driver, cables, plug)**  
100-240Vac input, 16W, 24Vdc output  
Plugs: EU, USA (Japan), UK, CCC  
Color: black

Recommended for table lamp, can also be used for floor lamp

# axolight.us

**AXO LIGHT USA INC**

1410 Broadway, Ste 2104

New York, NY 10018

+1 845 793 6590

+1 845 793 6598

[info@axolightusa.com](mailto:info@axolightusa.com)